

my_ScienceBox

We bring your research to μ -gravity

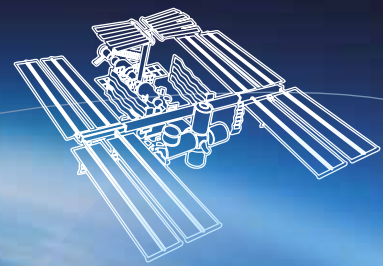

YOUR SMALL CUBE FOR GREAT POSSIBILITIES

AIRBUS Defence and Space develops and builds integrated systems, which allow research in micro gravity. Our research platform on the international space station (ISS) is used for different experiments in micro gravity. Every experiment is processed fully automated in its own cube – the ScienceBox. This approach minimizes the effort for the astronauts and reduces the accruing costs tremendously.

PROJECTABLE PROCESSES

Using the ScienceBox you can plan and implement your micro gravity experiments in a standardized research environment. We as AIRBUS Defence and Space are more than willing to support you in every phase of the project with our knowledge and experience:

- Transfer your own ideas to product development
- Push your internal research and development
- Clear cost strategy through transparent planning
- Short test periods
- Standardized interfaces and systems
- Web based access during flight phase
- End-to-end service

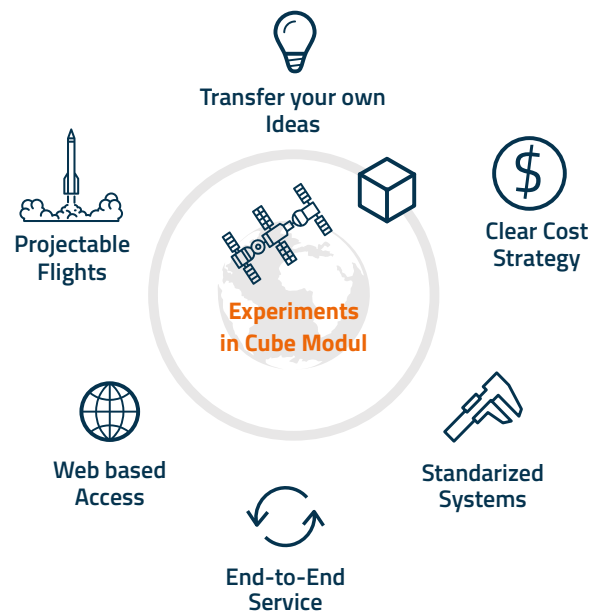

VARIOUS EXPERIMENTS POSSIBLE

Inside the ScienceBox you can process most different experiments from various fields, e.g. biosystems, pharmacologic research or material science. Take your crucial competitive advantage in research and development.



Technology Experiment

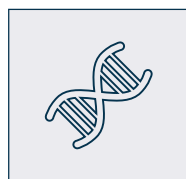

Life Science

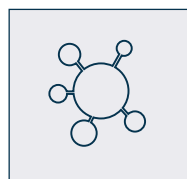

Physical Science

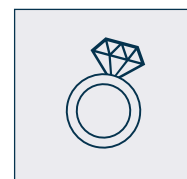

Added Value

Contact us for detailed informations:
Airbus Defence and Space GmbH
E-Mail: MySciencebox@airbus.com
Phone: +49 (0)7545-8-5825



AIRBUS

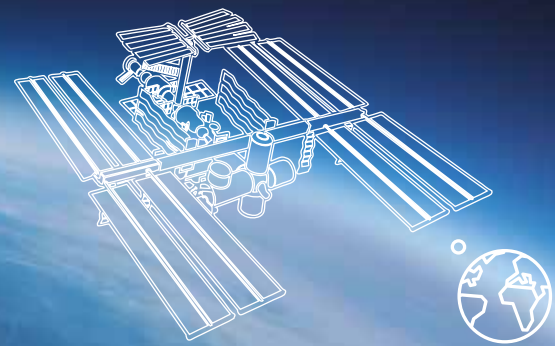
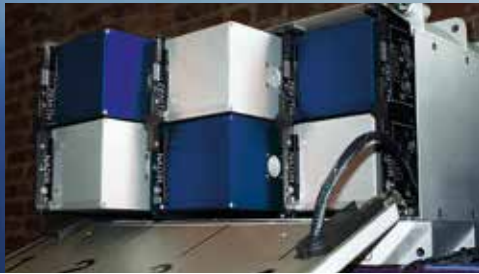

SCIENCEBOX

The ScienceBox is our research platform which was developed for reconfigurable ecosystem experiments in micro gravity on ISS. Due to our longtime experiences in space and on earth with governmental requirements we are experts in the field of research in low earth orbit. As such we have a modular construction system developed independent from the ISS, safe and divisible. This system allows our customers and partners to execute experiments in space efficient, reliable and high performance but simultaneously faster and more beneficial as before.

The AIRBUS Defence and Space ScienceBox offers a unique scope of operation:

- End-to-end and cloud based customer portal
- Real-time regulation
- Different possible sensor measurements
- Telemetry



CUBE MODULE

Inspired by the CubeSat community our research platform is using these standards as guideline for concept and development of experiments. Similar to the CubeSats those 10cm cubes can be combined to double, triple or 8 units to adjust the size to the requirements. The modules also are equipped with spacer (separation feet) on one side to separate to the neighbored payloads.

TELEMETRY

The customer portal is a web based application which allows each end customer, researcher or interested party to view telemetry in real-time von everywhere in the world. Additionally the portal and software can be used for follow-on test or improvements of the different factors of each experiment. The customers and engineers can do this independent from their location.

This research platform was developed by customers for customers; while we circle the world from today, we enable the solutions from tomorrow.

HARDWARE SPECIFICATIONS:

- Volume: approximately 1l, Cube with 10x10x10 cm
- Mass: up to 1.25kg
- Power: 7.5 Watts total; provided 3.3V, 5V and 12-Volt power rails
- Data: 255 Byte Packets at 1 Hz (1MBaud 3.3V UART)
- Provided Services: Power Telemetry, Imaging, Customer Portal

Further Informations: www.my-experiment-in.space/mysciencebox



Airbus Defence and Space GmbH
On-Orbit Services and Exploration
my_biorack / ScienceBox
Claude-Dornier-Straße
D-88090 Immenstaad
Germany

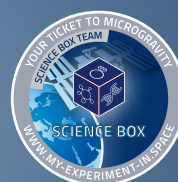

AIRBUS